

System filling **Guide**

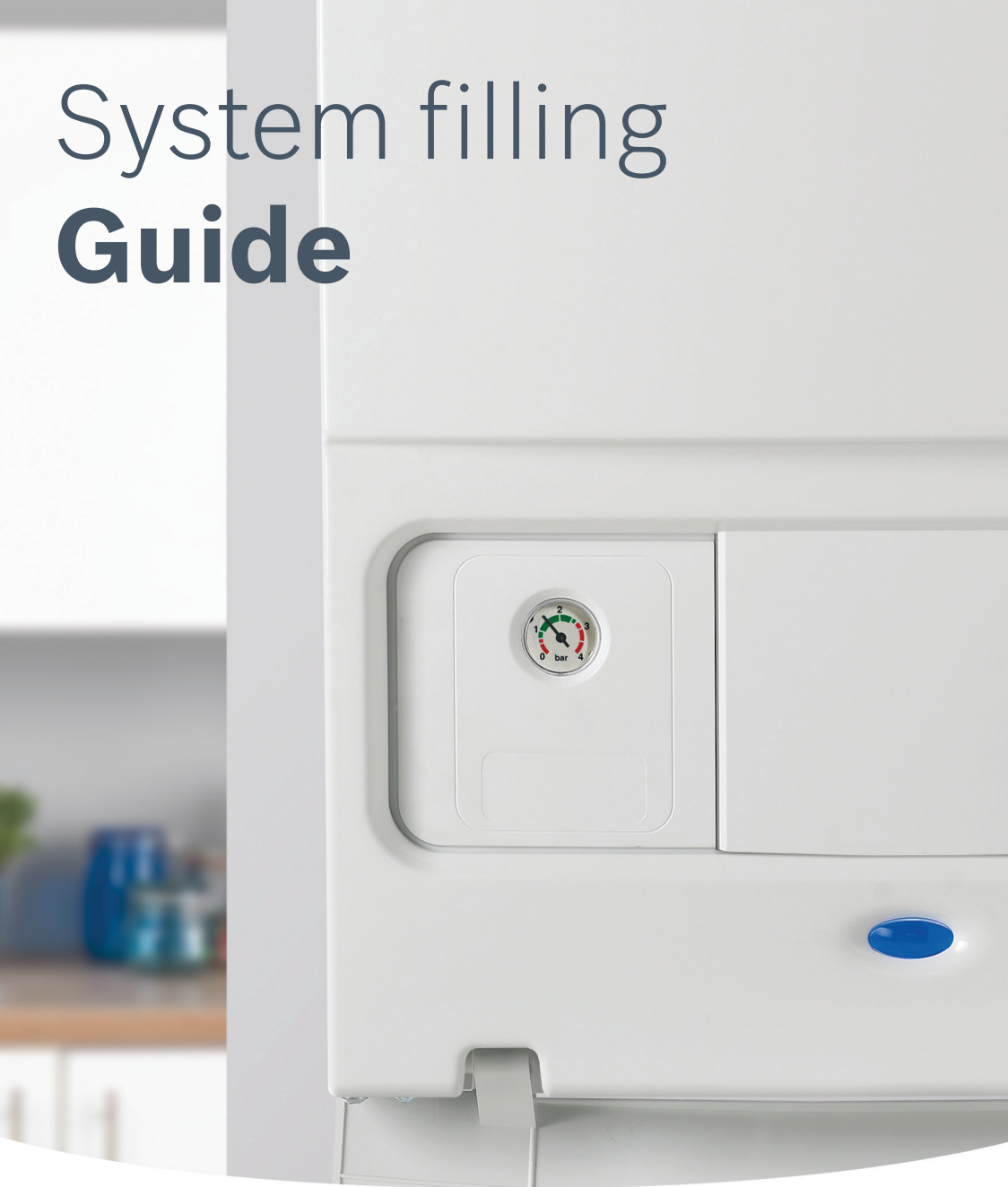

System Filling **Guide**

- Checking your system pressure 3
- Which is your filling link? 4
- Operating your external filling link 5
- Operating your keyed filling link 6
- Operating your keyless filling link 7

Checking your system pressure

To maintain the high efficiency of your boiler and heating system, it is advised that you regularly check the system operating pressure as indicated by the gauge located on the fascia panel of your appliance.

A sealed system relies on an operating pressure of between **1 and 1.5 bar** to deliver heating and hot water at a consistently comfortable and reliable level.

The gauge is designed to clearly show the system pressure while in operation and the green area on the display indicates where the needle should be.

Ideally, the needle should be somewhere within **section A** as shown in the diagram.

When the needle is seen in the red area, the boiler and system will probably not function at it's best. If this is observed frequently, it could indicate a leak in the system, where the needle is at its lowest, or a problematic system or boiler fault when the needle is at its highest. In this case your boiler is fitted with safety features that will either discharge any overloading of the system or, where necessary, shut off the boiler.

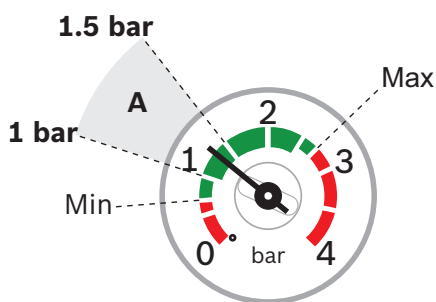

In cases where the pressure falls below the minimum operating level, the system can be easily refilled using the appropriate method shown in this guide.

It is advised that should the system need refilling on a **very regular basis**, a plumber should be called to check for leaks in pipes or more likely, radiator valves.

Should there be evidence that the boiler is **frequently exceeding** the operating pressure or regularly discharging or shutting down, then a heating engineer should be called.

Which is your filling link?

There are 3 different methods, depending on which the installer has fitted, by which you can refill your system. 2 are attached to the boiler the other within the vicinity of the appliance.

External filling link
A looped hose method.

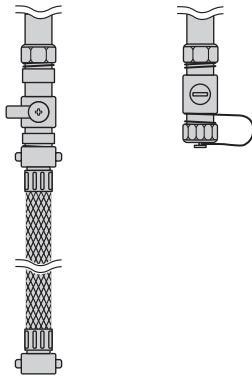

Usually unconnected, this will loop upwards or downwards and will be externally located either beneath or beside and close to the boiler.

Keyed filling link
An integral method.

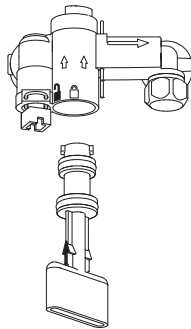

This is connected to and found beneath and to the right of the boiler. It is operated by a key which is located in the removable panel beneath the boiler.

Keyless filling link
An integral method.

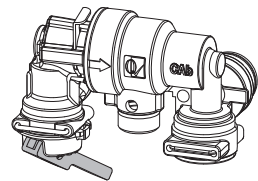

This is connected to and found beneath and to the right of the boiler. It is operated by an integral lever. Access via removable panel beneath the boiler.

All 3 methods are easy to use. Watch the gauge closely as the system fills. It may fill quite quickly so be ready to shut off the link when the needle is between 1 and 1.5 bar.

If the pressure is or rises above 1.5 bar. Bleed a radiator until the pressure gauge returns to between 1 and 1.5 bar.

Operating your external filling link

In the case of the external filling link, you may find that it is different to the below in that it might be connected and has 2 levers or screwdriver slots. The filling operation is the same, but if found connected it is best to leave it as installed.

1. Unscrew blanking cap.

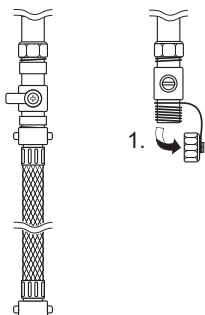

2. Attach the hose to the valve, screw on hand tight.

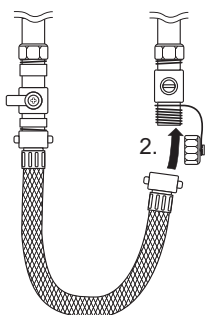

3. Turn handle/screwdriver slot through 90° to open valves.

4. The handle/screwdriver slot will be in line with the valves.

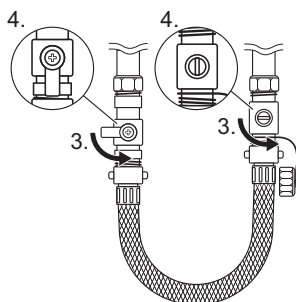

5. When the pressure reaches between the 1 and 1.5 bar marks (zone A), turn the handle/screwdriver slot back, through 90° to the valves.

6. The handle/screwdriver slot will be 90° to the valves.

7. Remove the hose and replace the blanking cap.

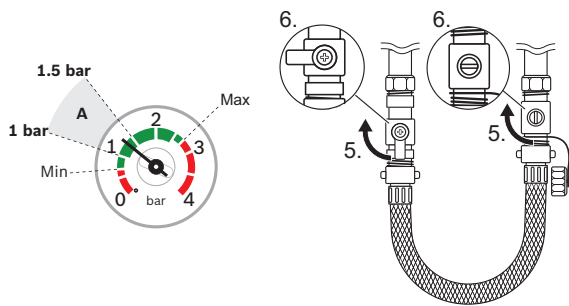

Operating your keyed filling link



In the case of the keyed filling link, it is necessary to locate the key (see above). Remove the bottom panel by pulling the catch down and then pulling the panel forward and down to remove. If the key is displaced you may order a spare key by calling customer service: 0330 123 9559.

1. Push the filling key firmly into the body of the filling link, ensuring the arrow in the key shaft lines up with the open padlock symbol.

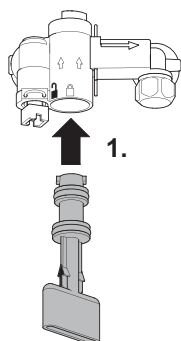

2. Turn the key to the right, to the stop, ensure the key is locked and that it cannot still turn. The arrow should now line up with the closed padlock symbol.

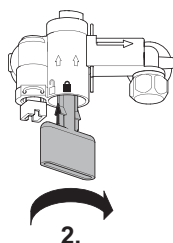

3. Turn the white knob to the left, this will allow water to fill the system.

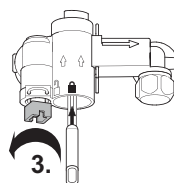

4. When the pressure, shown on the pressure gauge, reaches between the 1 and 1.5 bar marks (zone A), turn the white knob to the right to close the valve. Do not over-tighten.

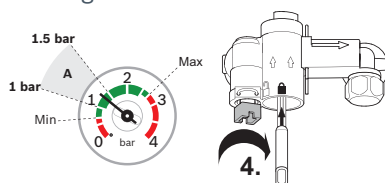

5. Turn the key to the left, to the stop, so that the arrow lines up with the unlocked padlock symbol and pull the key straight down.

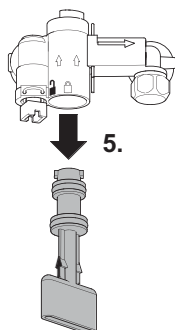

Please remember to store the key in the bottom panel.

Operating your keyless filling link



In the case of the keyless filling link, the system is filled using an integral lever. To access the filling link, remove the bottom panel by pulling the catch down and then pulling the panel forward and down to remove.

The integral filling link will be located to the right hand side of the appliance.

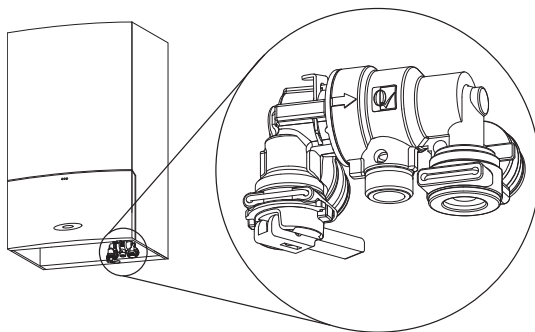

1. Pull the blue lever down to begin the filling process.

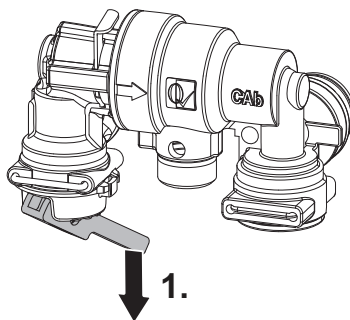

Monitor the system pressure gauge on the appliance fascia.

When the needle reaches between the 1 and 1.5 bar marks (zone A), **release** the blue lever to stop the filling process.

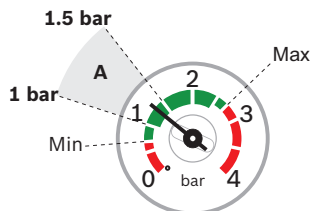

worcester-bosch.co.uk