

# WR 325 RSF

Room Sealed Fan-Assisted Multipoint Water Heater

GC NUMBER

??-??-??

## USER INSTRUCTIONS & CUSTOMER CARE GUIDE

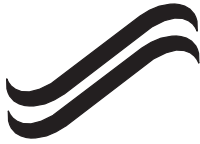

# EXCELLENCE COMES AS STANDARD

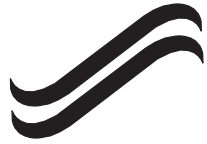

Thank you for purchasing a Worcester WR 325 gas-fired water heater.

The Worcester WR 325 appliances are made by Bosch Thermotechnik and the strictest quality control standards are demanded throughout every stage of production.

Indeed, Worcester Heat Systems have led the field in innovative appliance design and performance for more than 30 years.

The result is that your new Worcester WR 325 appliance offers you the very best of everything - quality, efficiency, economical running costs, proven reliability and value for money.

What's more, you also have the assurance of our no-nonsense 1 year parts and labour guarantee.

And it's backed up by Worcester Care Call - a complete maintenance scheme to keep your water heater operating at peak condition and efficiency.

No wonder that more and more people are agreeing that when it is gas, it has to be Worcester.

## CONTENTS

	Page No.
Operating Instructions .....	3-10
Fault and Breakdowns .....	11
Maintenance and Extended Warranty Information .....	12-14
Guarantee Details .....	15



# GENERAL INFORMATION



## **GAS SAFETY (INSTALLATION AND USE) REGULATIONS 1998**

It is the law that all gas appliances must be installed by a competent person in accordance with the above regulations. Failure to correctly install appliances correctly could lead to prosecution. It is in your interest and that of safety to ensure compliance with the law. The manufacturers notes must not be taken, in any way, as over-riding statutory obligations.

**IMPORTANT:** To get the best from your Worcester WR 325 please read these instructions carefully.

**NOTE:** In the event of a fault the appliance should not be used until the fault has been corrected by a competent person.

## **GENERAL DESCRIPTION**

The WR 325 is a room sealed fan-assisted multipoint water heater.

It is the law that all gas appliances are installed by a Corgi registered installer.

Failure to correctly install appliances can lead to prosecution.

### **Technical Data**

Appliance Type	WR325	
	Nat. gas	L.P.G.
Rated Input (Qn)	24.3 kW	24.3 kW
Maximum Rated Output (Pn)	21.4 kW	21.4 kW
Minimum Rated Output (Pmin)	7.0 kW	7.0 kW
Gas Rate (maximum)	2.6 m <sup>3</sup> /h	1.9 kg/h

# Performance

## Temperature control turned fully anti-clockwise

12 litres/minute at 25°C temperature rise

## Temperature control turned fully clockwise

6 litres/minute at 55°C temperature rise

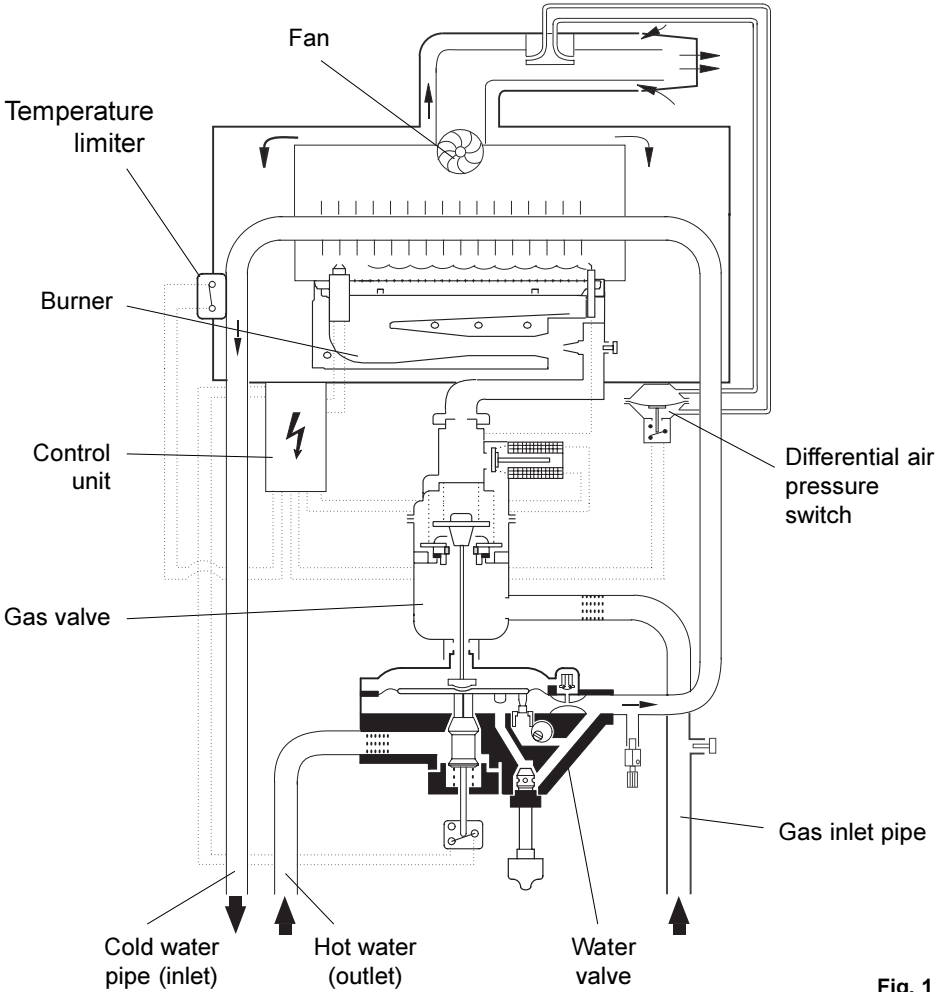

Fig. 1



# GENERAL NOTES



## CLEARANCES

Your installer will have provided adequate space around the appliance for safety and servicing. Do not restrict this space by the addition of cupboards, shelves etc. close to the appliance.

Minimum clearances in millimetres.

Above the turret	30 mm
In front	600 mm
Below	200 mm
Right-hand side	10 mm
Left-hand side	10 mm

## **SHOWERS, BIDETS, TAPS AND MIXING VALVES**

Hot and cold taps and mixing valves used in the system must be suitable for operating at mains pressure.

Thermostatically controlled shower valves will guard against the flow of water at too high a temperature.

If using a pressure equalising valve, set the Domestic Hot Water temperature control knob to the 'MAX' position.

Hot and cold mains fed water can be supplied direct to an over-rim flushing bidet subject to local Water Company requirements.

With all mains fed systems the flow of water from the individual taps will vary with the number of outlets operated simultaneously and the cold water mains supply pressure to the property. Flow balancing using 'Ball-o-Fix' type valves is recommended to avoid an excessive reduction in flow to individual outlets. For further information contact Worcester Heat Systems Technical Helpline.

## **HOT AND COLD FLOW**

If the flow of water demanded from both hot and cold service outlets is dependent upon mains supply, it may not be possible in some installations to operate all outlets simultaneously.

## **WATER MAINS FAILURE**

It is important to note that in the event of a mains water supply failure, no tap water will be available until the mains supply is restored.

## **USE IN HARD WATER AREAS**

Normally there is no need for scale protection. However, in areas of exceptionally hard water supply it is recommended that an In-Line scale inhibitor be fitted.

Installation should be strictly in accordance with the requirements of the local Water Company. An isolating valve to facilitate servicing should be incorporated.

The water hardness may be determined using the standard test paper or by reference to the local Water Company.

Further information may be obtained from Worcester Heat Systems Technical Helpline.

## **VENTILATION OF ROOM SEALED FANNED FLUE (RSF) APPLIANCES**

These are room sealed appliances and do not require a supply of air for combustion from inside the building. Ventilation openings in a wall or door must not be obstructed. Do not allow the flue terminal fitted on the outside wall to become obstructed or damaged.

NOTE: Do not place anything on top of the appliance. If the appliance is fitted in a compartment do not use the compartment for storage purposes unless it conforms to the requirements of BS 6798:1987: Section 6. It is essential that the airing space is separated from the boiler space by a perforated non-combustible partition as described in BS 6798:1987.

## **FROST PRECAUTIONS**

If the appliance is not to be used for a long period of time and there is a likelihood of freezing, then the appliance should be drained. The Worcester Heat Systems Technical Helpline will advise you on suitable frost precautions.

## **SERVICE**

Annual servicing is important in order to ensure continuing high efficiency and long life for your appliance. In the event of any difficulty in making suitable servicing arrangements, Worcester Heat Systems Limited or other competent persons will discuss regular servicing arrangements and offer a comprehensive maintenance contract.

## **WARNING**

If a gas leak exists, or is suspected, turn off the gas supply to the appliance at the service cock and consult your local service engineer.

Do not touch any electrical switches to turn them either on or off. Open all windows and doors. Do not smoke. Extinguish all naked lights.

## **CLEANING**

Do not use abrasive cleaners on the outer casing. Use a damp cloth and a little detergent.

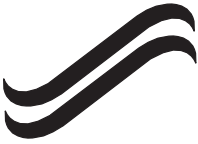

# OPERATION OF CONTROLS



## Operation

### Starting up (see fig. 2)

Domestic Hot Water: With a demand for hot water the burner will light and then automatically adjust its output to maintain the temperature of the delivered water.

### Switching On/Off

#### Switching On:

Turn the on-off switch to position "1"

#### Switching Off:

Turn the on-off switch to position "0"

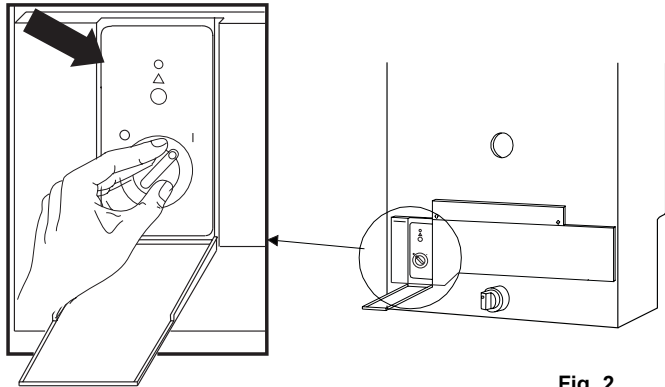

Fig. 2

### Temperature Control (see fig. 3)

The temperature Control Knob should be turned anti-clockwise to obtain a higher flow rate of water at a lower temperature rise, or turned clockwise to obtain a higher temperature rise at a lower flow rate.

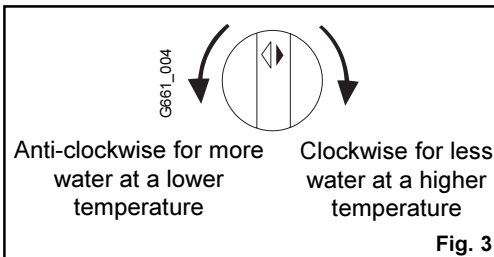

Fig. 3

### Shut Down (see fig. 2)

When hot water is no longer required, the burner will extinguish. The fan may continue to run for a short period to dissipate the residual heat from the appliance.

When hot water is required again, the pilot must be re-established.

If, during prolonged inactive periods, there is any risk of freezing, the heater should be drained by firstly isolating the appliance from the incoming cold water supply (close the water cock). Then open the taps and drain down.



### Safety Cut-Out

If the appliance does not light, open flap next to control panel.

If warning lamp is on (ignition has failed), press reset button (light will go out) and ignition procedure will be repeated.

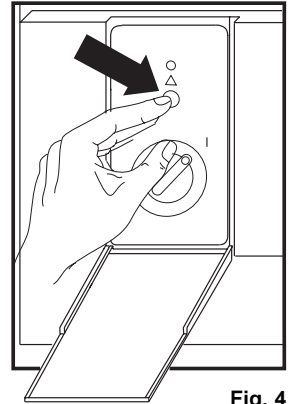

Fig. 4

### Servicing

To ensure continued efficient operation of the appliance it is recommended that it is checked and serviced as necessary at regular intervals.

The frequency of servicing will depend upon the particular installation conditions and usage but in general once a year should be adequate.

It is the law that any service work be carried out by a competent person such as British Gas or other Corgi registered personnel.

The casing should be wiped clean using a damp cloth

Do not use abrasive or corrosive cleaners

**Fig. 6 - Controls**

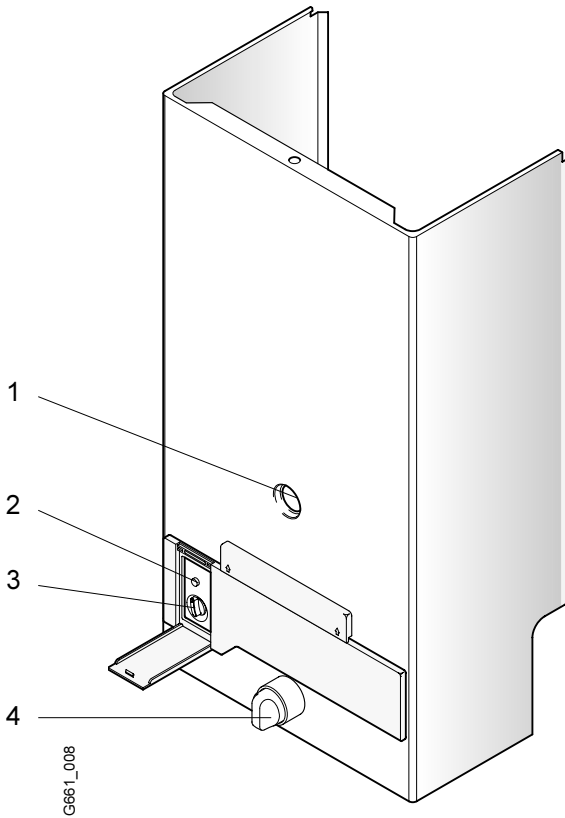

G661\_008

**Fig. 5**

- 1 Observation window
- 2 Reset button
- 3 On/Off switch
- 4 Water flow selector

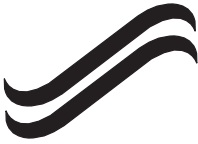

# APPLIANCE FAILS TO OPERATE

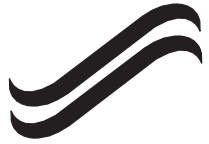

More than 30% of all calls made to Worcester Heat Systems to report appliance faults or breakdowns prove to be false alarms, as there is often a simple explanation for the apparent malfunction.

So, to help you save time and money - not to mention frustration and inconvenience - please refer to the General Information, Notes and Lighting Instructions ensuring all controls are set correctly.

If, after following the instructions the appliance still fails to operate correctly call the Worcester Heat Systems Service Centre.

Arrangements will be made for an engineer to call as soon as possible.

## CALL-OUT CHARGES

All of our field service engineers are factory trained.

If you request a visit from an engineer and your appliance has been installed within the last 12 months, no charge will be made for parts and/or labour, providing:

- The appliance was commissioned correctly on installation.
- An appliance fault is found and the appliance has been installed within the past 12 months.

A call-out charge will be made where:

- The appliance has been installed for over 12 months, or
- Our Field Service Engineer finds no fault with the appliance (see note), or
- The cause of breakdown is with other parts of your plumbing/heating system, or with equipment not supplied by Worcester.

**NOTE:** Invoices for attendance and/or repair work carried out on your appliance by any third party will not be accepted.

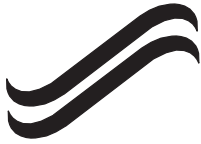

# MAINTAINING YOUR APPLIANCE



Your new Worcester gas-fired appliance represents a long-term investment in a reliable, high quality product.

In order to realise its maximum working life, and to ensure it continues to operate at peak efficiency and performance, it is essential that your boiler receives regular, competent servicing and annual maintenance checks beyond the initial 12 month guarantee period.

Regular service contracts can be arranged with your installer - however if you have difficulty making a satisfactory arrangement simply contact Worcester Heat Systems on 0345 256206 for help.

If you would like to know more about Worcester's extended warranty options please tick the appropriate box on your registration card.



# SERVICE CENTRES



<b>Region</b>	<b>Telephone</b>	<b>Fax</b>	<b>Opening Hours (Mon to Fri)</b>	<b>Sat</b>
Scotland	0345 256206	(01506) 441687	8.00 am to	9.00 am to
The rest	0345 256206	(01905) 757536	6.00 pm	1.00 pm

We have Service Centres situated throughout the country.

If you have a service request simply call our local rate number above and your request will be routed to your Regional Service Centre.

**NOTE:**

Should you have a service request outside normal office hours, please leave a recorded message giving as much information as possible to assist the administrator to deal with your request.

If the visit of an engineer is necessary your administrator will confirm any arrangement made.

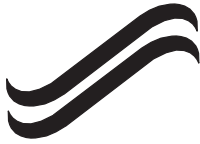

# **YOUR WORCESTER WR 325 GUARANTEE**



This appliance is guaranteed against faulty materials or workmanship for a period of twelve calendar months from the date of installation subject to the following conditions and exceptions.

1. That during the currency of this guarantee any components of the unit which are proved to be faulty or defective in manufacture will be exchanged or repaired free of material charges and free of labour charges by Worcester Heat Systems Limited.
2. That the householder may be asked to prove the date of installation, that the appliance was correctly commissioned and, where appropriate, the first 12 month service has been carried out to the satisfaction of Worcester Heat Systems Limited when requested.
3. That any product or part thereof returned for servicing under the guarantee must be accompanied by a claim stating the Model, Serial Number, Date of Installation.
4. That Worcester Heat Systems Limited will not accept responsibility for damage caused by faulty installation, neglect, misuse or accidental damage, the non-observance of the instructions contained in the installation and Operating Instructions Leaflets.
5. That the appliance has been used only for normal domestic purposes for which it was designed.
6. That this guarantee applies only to equipment purchased and used in mainland Great Britain.

This guarantee is given in addition to all your normal statutory rights.



# GUARANTEE REGISTRATION



You should complete and return the postpaid Guarantee Registration Card within 14 days of purchase.

The card will register you as the owner of your new Worcester appliance and, while this will not affect your statutory rights in any way, it will assist us to maintain an effective and efficient customer service by establishing a reference and permanent record for your boiler.

**IMPORTANT: SERIAL NUMBER.** Copy the number off the Guarantee Card.

FOR YOUR OWN RECORD

MODEL

SERIAL NUMBER

(See identity label inside appliance casing)

TYPE/SIZE

DATE OF INSTALLATION



EXCELLENCE COMES AS STANDARD

Worcester Heat Systems Limited, Cotswold Way, Warndon, Worcester WR4 9SW.  
Telephone: (01905) 754624. Fax: (01905) 754619 Technical Helpline (0990) 266241

6 720 605 998 PT 2000.03